



The eBike Display
User Manual

KD58C

Contents

Product name and model.....	1
Specifications.....	1
Appearance and Size.....	1
Function and Button Definition.....	2
◆Function Summary.....	2
◆Function Layout.....	2
◆Button Definition.....	2
Install Instructions.....	2
General Operation.....	2
◆Switching the E-bike System On/Off.....	2
◆Display Interface.....	2
◆Switching Push-assistance mode On/Off.....	3
◆Switching the Lighting On/Off.....	3
◆Assist Level Selection.....	3
◆Power Indicator.....	4
◆Error code Indication.....	4
General Settings.....	4
◆Trip Distance Clearance.....	5
◆Toggle the unit km/mile.....	5
◆Wheel Diameter Settings.....	5
◆Speed limit Settings.....	6
◆Battery Power bar Settings.....	6
Personalized Parameter Settings.....	6
◆Assist Level Settings.....	7
Assist Level mode options.....	7
Assist Level ratio settings.....	7
◆Controller Over-current Cut Settings.....	8
◆Power Assist Sensor settings	8
◆Speed Sensor Settings.....	8
◆Slow Start up Settings	9
◆Backlight Brightness Settings.....	9
◆Power-on Password Settings.....	10

Power-on Password Enable/Disable.....	10
Power-on Password Change.....	10
◆Exit settings.....	10
Recover default settings.....	11
Quality assurance and warranty scope.....	11
Connection layout.....	12
Warnings.....	12
Attached list 1 Error code definition.....	13
Attached list 2 Assist level ratio defaults.....	13

Product name and Model

Electric Bicycle Intelligent Display,
Model: KD58C.

Specifications

- 24V/36V /48V Power Supply
- Rated current: 10mA
- The maximum working current: 30mA
- Off-state leakage current: $<1\mu\text{A}$
- Working temperature: $-20 \sim 60\text{ }^{\circ}\text{C}$
- Storage temperature: $-30 \sim 70\text{ }^{\circ}\text{C}$

Appearance and Size

Display appearance and dimensional drawing (unit: mm)

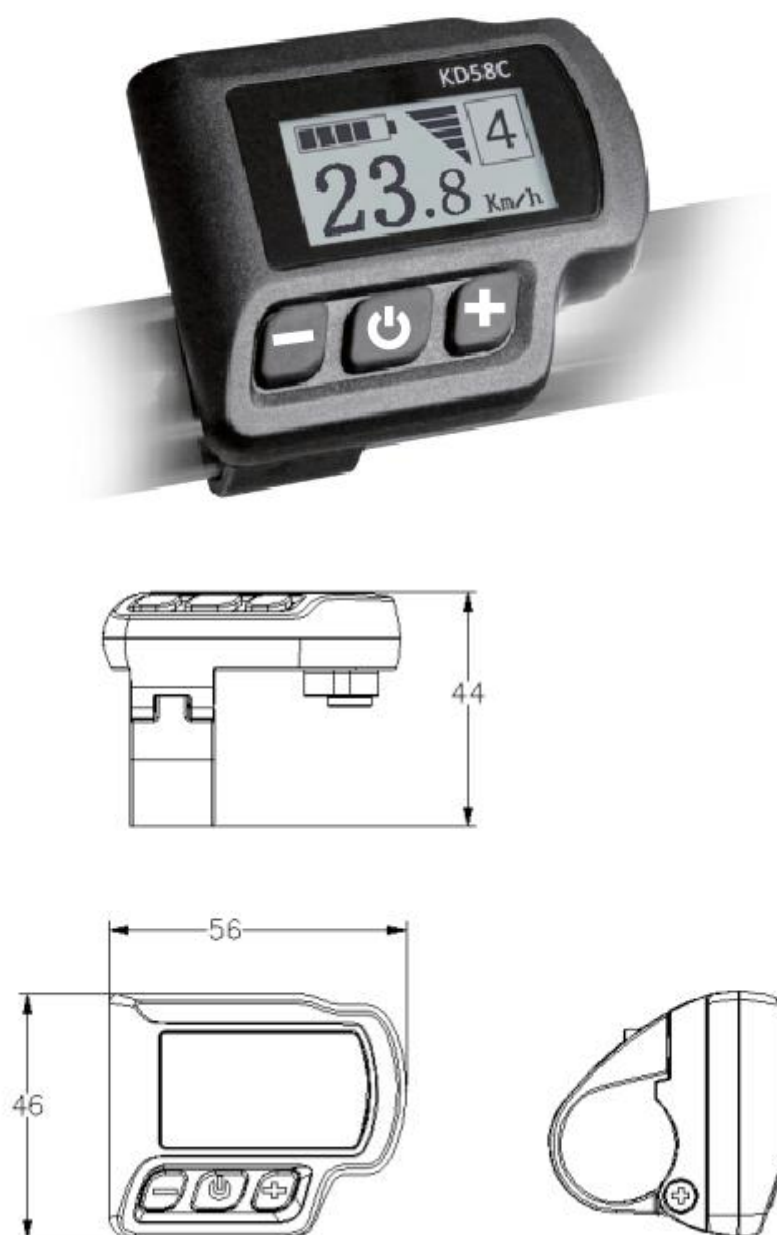

Function and Button Definition

◆Function Summary





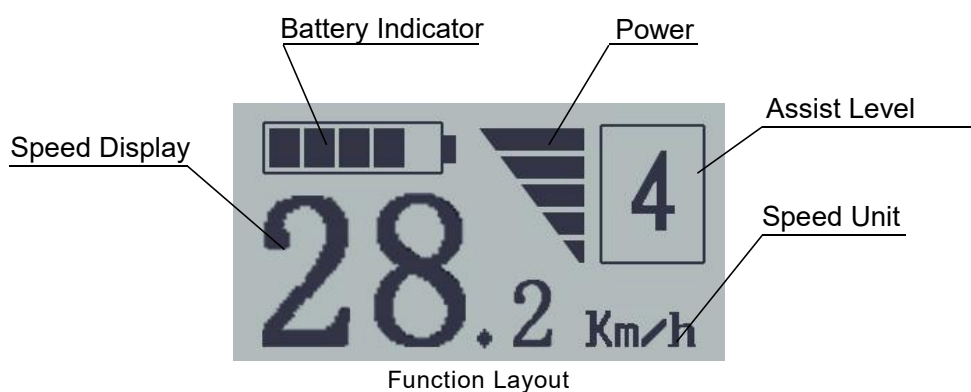

KD58C has a lot of functions to meet the riders' needs. The indication elements are as follows:

- Battery SOC
- Assist level
- Speed indication (incl. Current speed, Max. speed and Avg. speed)
- Motor-output indicator
- Trip time
- Trip distance and Total distance
- The push-assistance function
- Switch the Lighting On/Off
- Error Code indication
- Various Parameters Settings (e.g., wheel size, speed-limited, battery level bar, PAS level, password enable, controller limited current etc.)
- Recover Default Settings

◆Function Layout



◆Button Definition

There are three buttons ( ,  , ) on KD58C display. In this manual, we use words **ON/OFF**, **UP**, **DOWN** to represent these 3 symbols ( ,  , ).

Install Instructions

KD58C can be mounted on the left side of handlebar close to its grip. Adjust the angle for a good screen view. Cut off the power before connecting the corresponding connectors between display and controller.

General Operation

◆Switching the E-bike system On/Off

To switch on the E-bike system, hold the **ON/OFF** button for 2s.

To switch off the E-bike system, hold the **ON/OFF** button for 2s.

When E-bike system is switched off, the leakage current is less than 1 μ A.

■When E-bike is parked for approx. 10 minutes, the E-bike system switches off automatically.

◆Display Interface

After the E-bike system is switched on, the display shows current speed by default.

Press **ON/OFF** button to switch between indication functions below:

Current Speed (Km/h) → Trip Distance (Km) → ODO(Km) → Trip Time (Hour) → Average Speed (Km/h) → Max Speed (Km/h). Each state will display for 2 seconds and it automatically cycles back to current speed interface again.

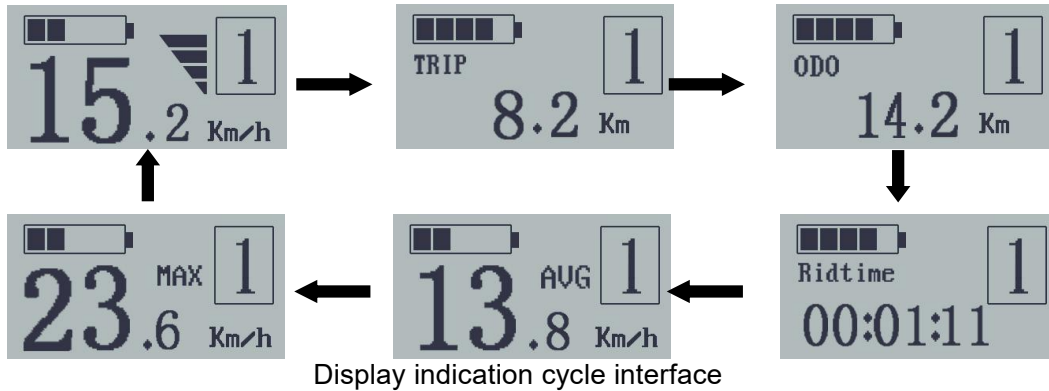

◆ **Switching Push-assistance Mode On/Off**

To activate the push-assistance function, press and hold the **DOWN** button. After 2 seconds, the E-bike will go on at a uniform speed of 6 Km/h and “P” is shown on the screen at the same time. The push-assistance function is switched off as soon as you release the **DOWN** button.



Push-assistance Mode

■ **Push-assistance function may only be used when pushing the E-bike. Be aware of danger of injury when the wheels of E-bike do not have ground contact while using push-assistance function.**

◆ **Switching the Lighting On/Off**

To switch on E-bike lights, hold the **UP** button for 2s. The E-bike lights will be switched on while display backlight darkens.

Likewise, hold the **UP** button for 2s again, the E-bike front light will be switched off while display backlight recovers the brightness.

■ If E-bike lights are independent of “**UP**” button, the “**UP**” button can only be used to switch on/off the display backlight.

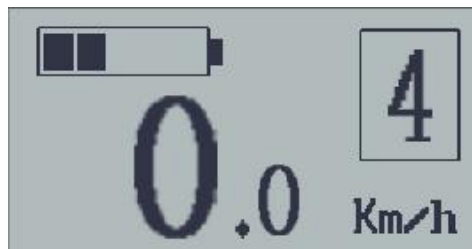

Switch the Lighting on/off

◆ **assist Level options**

Assist levels indicate the output power of the motor. The default value is level “1”.

The default power ranges from level “0” to level “5”. The output power is zero on Level “0”. Level “1” is the minimum power. Level “5” is the maximum power.

Press **UP/DOW** to change the assist level.



Assist Level "4"

◆ Power Indicator

The output power of the motor can be indicated by below interface.



Motor Power Interface

◆ Error code Indication

The components of the E-bike system are continuously and automatically monitored. When an error is detected, the respective error code is indicated in text indication area.

Refer to the detailed definition of the error codes in **Attached list 1**.

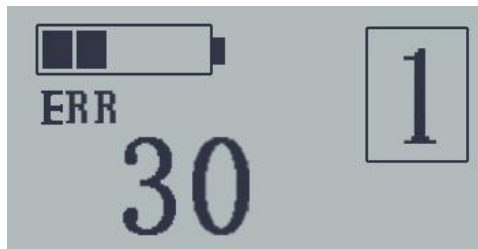

Error Code Indication

■ **Have the display inspected and repaired when an error code appears. Or else, you will not be able to ride the bike normally. Please always refer to an authorized bicycle dealer.**

General Settings

After the E-bike system is switched on,

To access **General Settings** menu, hold both the **UP** and **DOWN** button simultaneously for 2s.

Press the **Up** or **DOWN** button to choose setting items and press **ON/OFF** to enter the setting interface.

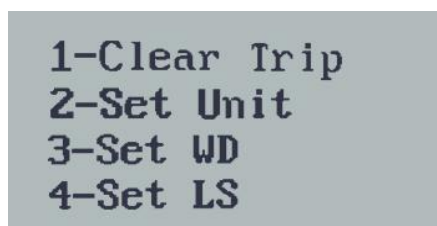

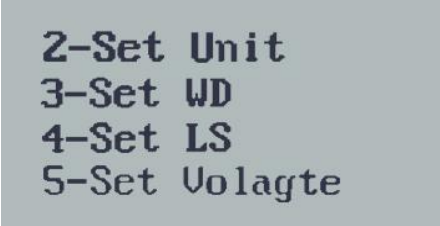

2-Set Unit
3-Set WD
4-Set LS
5-Set Volagte

General Settings interface

◆ Trip Distance Clearance

Clear Trip means trip distance clearance. Press the **UP** or **DOWN** button to choose YES or NO. The default value is NO.

To clear a trip, choose YES and press the **ON/OFF** button to confirm. The screen says 'OK' and returns to the General Settings interface.



Clear Trip
YES/NO

Trip distance clearance

◆ Unit Mile/KM toggling

Set Unit represents unit settings. The default value is Metric 'KM'

To toggle unit, press **UP/DOWN** until the desired unit is displayed.

To store a changed setting, press the **ON/OFF** button to confirm. The screen says 'OK' and then returns to General Settings interface.

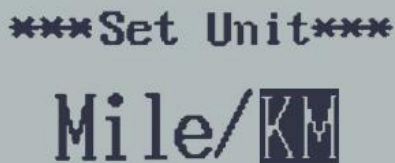

Set Unit
Mile/KM

Mile and Kilometer Toggling Interface

◆ Wheel Diameter Settings

Set WD represents wheel diameter settings. Optional values are 16, 18, 20, 22, 24, 26, 700C and 28. The default value is 26 inch.

To change basic settings, press **UP/DOWN** to increase or decrease until the desired value is displayed.

To store a changed setting, press the **ON/OFF** button and the screen says 'OK' and then returns to General Settings interface.

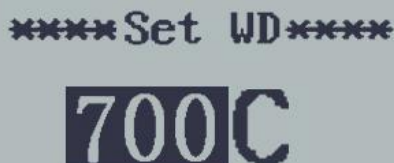

****Set WD****
700C

Wheel Diameter Settings Interface

◆Speed limit Settings

Set LS represents speed limit settings. When current speed is faster than speed limit, the E-bike system will be switched off automatically. Limited speed range is 12Km/h to 40Km/h. The default value is 25Km/h.

To change basic settings, press **UP/DOWN** to increase or decrease until the desired value is displayed.

To store a changed setting, press **ON/OFF** button and the screen says 'OK' then returns to General settings interface.



Speed Limit Settings Interface

◆Battery Power bar Settings

Set Voltage represents voltage settings. Each bar represents a voltage value. 5 bar-voltage values must be entered one by one.

For example, Vol-1 is the first bar voltage and the default value is 31.5V. Press **UP/DOWN** to increase or decrease the voltage value.

To store a changed setting, press the **ON/OFF** button and access the second bar setting.

After 5 bar-voltage values are entered, press **ON/OFF** button to confirm. The screen says 'OK' and then returns to General settings interface.



Battery Power Bar Settings

Personalized Parameter Settings(*Specific Set*)

Personalized Parameter Settings(*Specific Set*) can meet various riders' requirements.

Hold both **UP** and **DOWN** button for 2s to enter **General Settings** and hold the **UP** and **DOWN** button for 2s again to enter **Personalized Parameter Settings** selection interface. Press the **UP** or **DOWN** button to choose the settings items, then press the **ON/OFF** button to enter the corresponding settings interface.

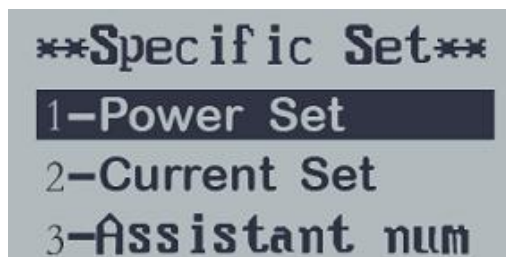

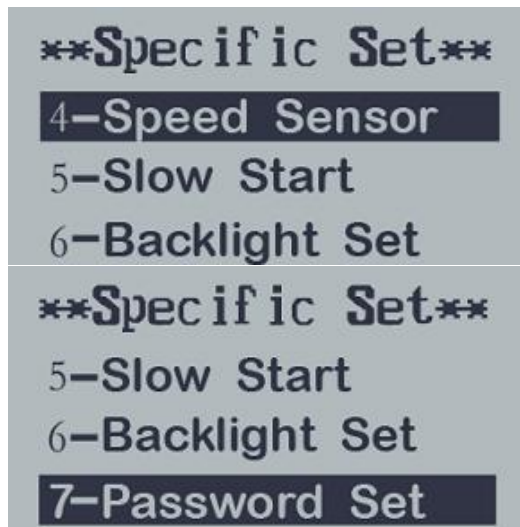

Personalized parameter settings Interface

◆ Assist Level Settings

Power Set means assist level settings

Power assist Level mode

In assist level settings, there are 8 modes for your choice: 0-3, 1-3, 0-5, 1-5, 0-7, 1-7, 0-9, 1-9. The default value is 0-5.

To select the mode of assist level, press **UP/DOWN** to increase or decrease until the desired mode is displayed.

To store a changed setting, press the **ON/OFF** button and access assist level ratio settings page.

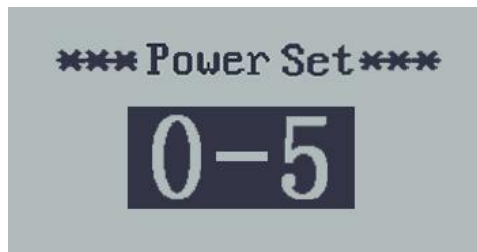

Assist level mode option interface

Assist Level Ratio settings

The speed of each assist level can be adjusted to meet different riders' needs by setting the ratios

For example, the default ratio is 50% for level "1"; the ratio range is "45-55 percent" for level "1".

To change the ratio of a certain assist level, press the **"UP"** button or **"DOWN"** button to choose the desired value, and press the **"i"** button to confirm and then move to the next level ratio settings.

After ratios of all levels are set, hold the **"DOWN"** button for 2s to confirm and return to previous menu. For ratio default values, please refer to **Attached list 2**.



Assist Level Ratio Settings

◆ Controller Over-current Cut Settings

Current Set represents controller over-current cut settings. The current value can be changed from 7.0A to 25.0A.

To change basic settings, press the “+” or the “-” button to increase or decrease the value of the current.

To store a changed setting, press the “ON/OFF” button. The screen says “OK” and returns to previous menu.



Current Settings Interface

◆ Power assist Sensor Settings

'Assistant num' represents the numbers of magnets on PAS disk. The default number is 12. The adjustable range is 5 to 24.

To change the number of magnets on PAS disk, press “UP” or “DOWN” button to choose the desired quantity.

To store a changed setting, press the “ON/OFF” button. The screen says “OK” and returns to previous menu.

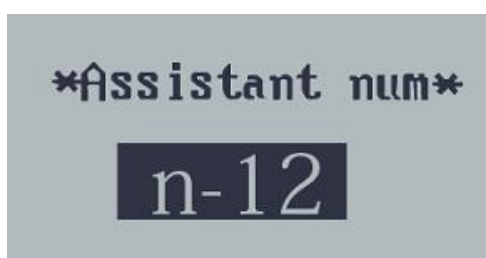

The PAS Magnet Quantity Settings

◆ Speed Sensor Settings

Speed Sensor represents speed sensor settings. The default value is 1.

To change speed sensor settings, press the “UP” or the “DOWN” button to select the quantity of magnets on the bike spokes (the range is from 1 to 15).

To store a changed setting, press the “ON/OFF” button. The screen says “OK” and returns to previous menu.



Speed Sensor Settings

◆ Slow Start up Settings

Slow Start represents slow start up. The range is 1-4 seconds. 4 is the slowest.

To change slow start up settings, press the **UP** or **DOWN** button to change the value and press the **ON/OFF** button to confirm. The screen says 'OK' and return to previous menu. The default value is 1.



Slow Start up settings interface

◆ Backlight Brightness Settings

Backlight Set represents backlight brightness settings. Level "1" is the low brightness, Level "3" is high brightness. The default level is "2".

To change the backlight brightness, press the "+" button or the "-" button to choose the desired brightness.

To store a changed setting, press the **"ON/OFF"** button. The screen says "OK" and returns to previous menu interface.



Backlight Brightness Settings Interface

◆ Power-on Password Settings

Password Set represents power-on password settings. The default password is 1212. When the screen shows P2:0000, you need to input the current password or the default password"1212".

Press **UP/DOWN** to change the numbers and press **ON/OFF** to confirm digits one by one until the correct 4-digit password is completed. Then press **ON/OFF** to access power-on password enable settings interface; otherwise stay still in the password input state.



Password Input Interface

Power-on Password Enable/Disable

Press the **UP** or **DOWN** button to choose Disable or Enable and press the **ON/OFF** button to confirm. The default value is Disable. If you choose Enable, press the **ON/OFF** button to enter Power-on Password Change interface; otherwise you will exit the power-on password settings.



Power-on Password Disable/Enable Interface

Power-on Password Change

When the display shows "Password Set, P3:0000", press the **UP** or **DOWN** button to change the numbers and then press the **ON/OFF** button to confirm digits one by one until a new 4-digit password is completed.

To store a new power-on password, hold the **ON/OFF** button for 2 seconds and then exit settings.

When you switch on the E-bike system next time, the display will show P1,0000, please input the new password to power on.



Power-on Password Change Interface

◆Exit settings

In the settings state,

Press the **ON/OFF** button to confirm the input.

Hold the **ON/OFF** button for 2s to save the settings and then exit the current settings.

Hold the **DOWN** button for 2s to cancel the operating but not to store the settings, and then return to previous menu.

■If there is not any operations in one minute, display will exit the settings state automatically.

Recover default settings

dEF means recover default settings. Press both the **UP** and **ON/OFF** button for 2 s to enter recover default settings. Press the **UP** or **DOWN** button to choose Y or N. Y means that recovers default settings. N means that do not recover default settings. When it is Y, hold the **ON/OFF** button for 2 s to recover default settings, the display shows 'dEF-00' at the same time, and then return to general display state. The default value is N.



Recover Default Settings Interface

Quality assurance and warranty scope:

I. Warranty:

- 1) The warranty will be valid only for products used in normal conditions.
- 2) The warranty is valid for 24 months after the shipment or delivery to the customer.

II. The following cases do not belong to warranty scope:

- 1) The display is demolished.
- 2) The damage of the display is caused by wrong installation or operation.
- 3) The shell of the display is broken after the display leaves the factory.
- 4) The cable of the display is broken.
- 5) Beyond warranty period.
- 6) The fault or damage of the display is caused by the force majeure (e.g., fire, earthquake, etc.).

Wire connection layout

Connector wire sequence

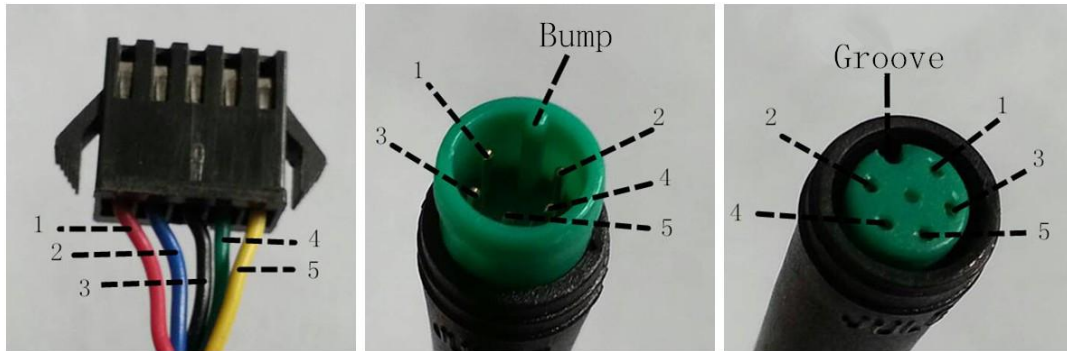

Connector to controller

display end

connection wire end to display

Wire sequence table

Wire sequence	Color	Function
1	Red(VCC)	+
2	Blue(K)	Lock
3	Black(GND)	-
4	Green(RX)	RX
5	Yellow(TX)	TX

■ Some products have wire connection with water-proof connectors, users can not see the color of lead wires in the harness.

Warnings:

1. Use the display with caution. Don't attempt to release or link the connector when battery is power on.
2. Try to avoid hitting the display.
3. Don't modify display background parameters to avoid parameter disorder. Or else, you will not be able to ride the bike normally.
4. Have the display repaired when it does not work properly.

■ This manual instruction is a universal version for **DISPLAY KD58C**. Some versions of this display may be different from specification to specification as to the software. Please always refer to an actual version.

Attached list 1: Error code definition

Error Code	Definition
21	Current Abnormality
22	Throttle Abnormality
23	Motor Phase Abnormality
24	Motor Hall Signal Abnormality
25	Brake Abnormality
30	Communication Abnormality

Attached list 2: Assist level ratio defaults

Level PAS level mode	1	2	3	4	5	6	7	8	9
0-3/1-3	50%	74%	92%	—	—	—	—	—	—
0-5/ 1-5	50%	61%	73%	85%	96%	—	—	—	—
0-7/ 1-7	40%	50%	60%	70%	80%	90%	96%	—	—
0-9/ 1-9	25%	34%	43%	52%	61%	70%	79%	88%	96%